

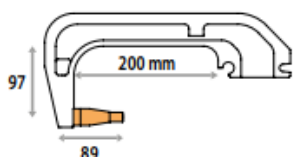

IMS biedt een groot assortiment aluminium C-armen aan. Deze armen zijn vloeistof gekoeld, en omvatten elektroden en lasdoppen. Sommige C-armen zijn ook geïsoleerd leverbaar zie ref. isole.



**C1 - 8bar/550 daN**

réf. 019140  
réf. 021402 isolé

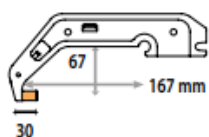

**C5 - 8bar/550 daN**

réf. 019294  
réf. 022393 isolé

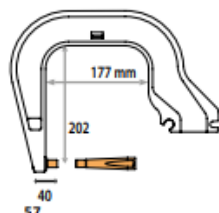

**C8 - 8bar/550 daN**

réf. 020016  
réf. 021440 isolé

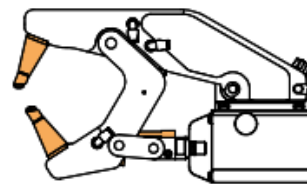

**C11 - 8bar/550 daN**

réf. 053649

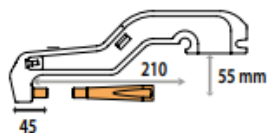

**C2 - 8bar/550 daN**

réf. 019133  
réf. 022386 isolé

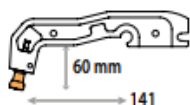

**C6 - 8bar/300 daN**

réf. 019775  
réf. 022409 isolé

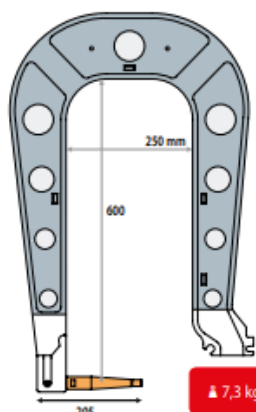

**C9 - 8bar/550 daN**

réf. 020078 isolé

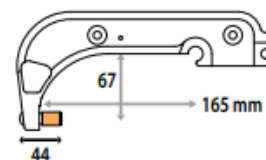

**C12 - 8bar/550 daN**

réf. 023000  
réf. 022997 isolé

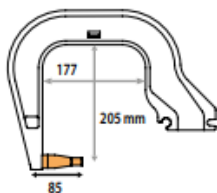

**C3 - 8bar/550 daN**

réf. 019157  
réf. 021419 isolé

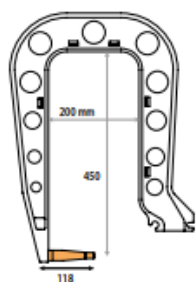

**C4 - 8bar/550 daN**

réf. 019164  
réf. 021426 isolé

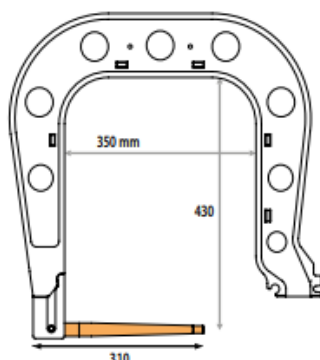

**C7 - 8bar/550 daN**

réf. 020009  
réf. 021433 isolé

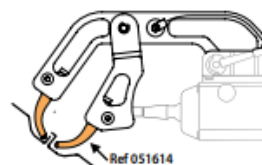

**C10 - 4bar/150 daN**

réf. 051638

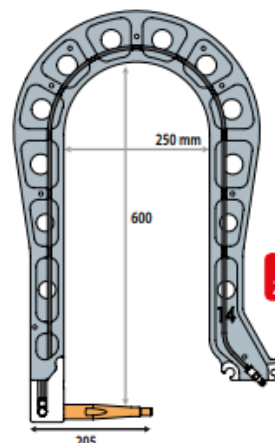

**C14 - 8bar/400 daN**

réf. 023543